

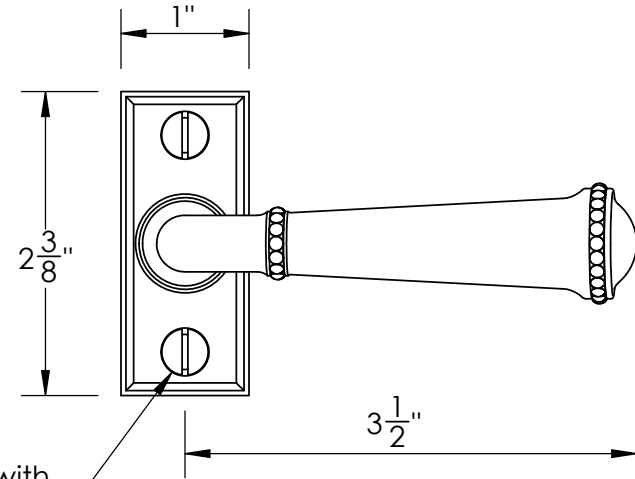

Shown above: 925-WMP-01
Other lever styles also available



Comes standard with
M5 X 25mm long screws

Available Backplate Styles:

-00
standard
1" x 2 3/8"



-01
decorative
1" x 2 3/8"



-02
beveled
1" x 2 3/8"



-03
slab
1" x 2 3/8"



-04
stepped
1" x 2 3/8"

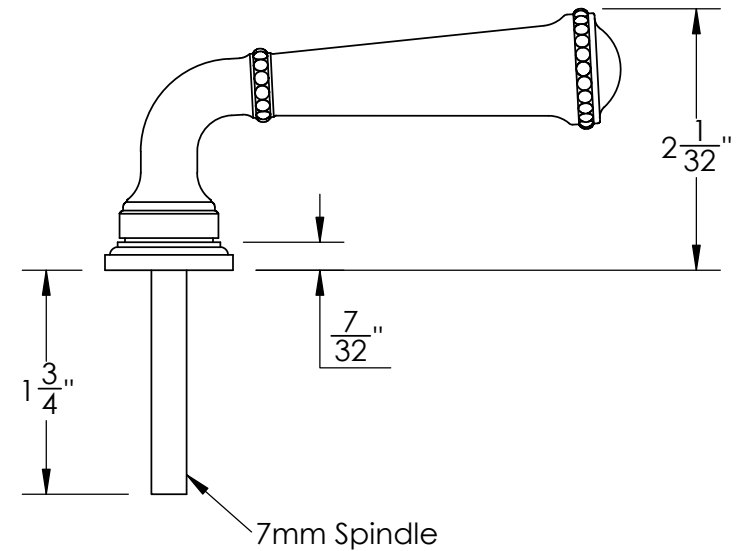

Merit Metal Products Inc.
242 Valley Road
Warrington, PA 18976
P 215-343-2500 F 215-343-4839

The information contained in this drawing is the sole intellectual property of Merit Metal Products. Any reproduction in part or as a whole without the written permission of Merit Metal Products is prohibited.

Unless Otherwise Specified:

Dimensions are in inches

All dimensions are from edge, theoretical sharp corner, or hole center.

	NAME	DATE
Drawn:	AJE	12/02/2019

Comments:

TITLE:
Window Multipoint

PART. NO.
925-WMP-01