

Shown above: 925-TNT-00
Other lever styles also available

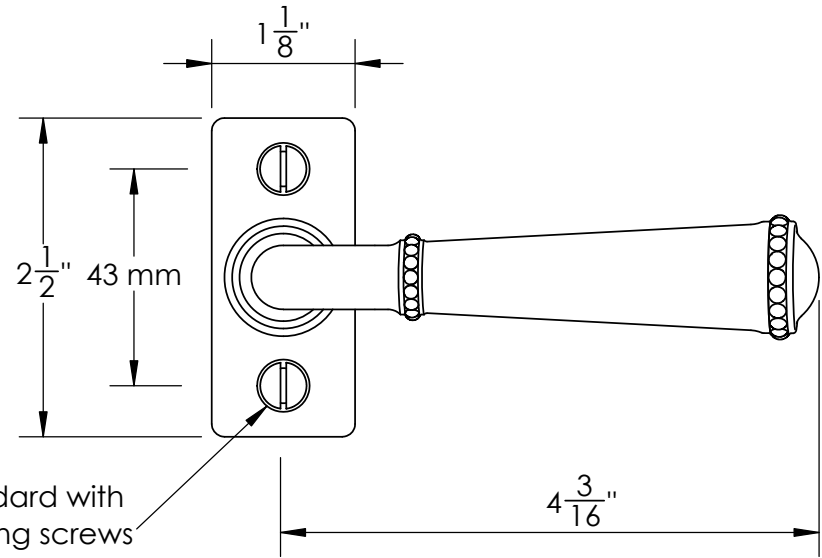

Comes standard with
M5 x 2.25" long screws

Available Backplate Styles:

-00
standard
1 1/8" x 2 1/2"



-01
decorative
1 1/2" x 2 3/4"



-02
beveled
1 1/2" x 2 3/4"



-03
slab
1 1/2" x 2 3/4"



-04
stepped
1 1/2" x 2 3/4"

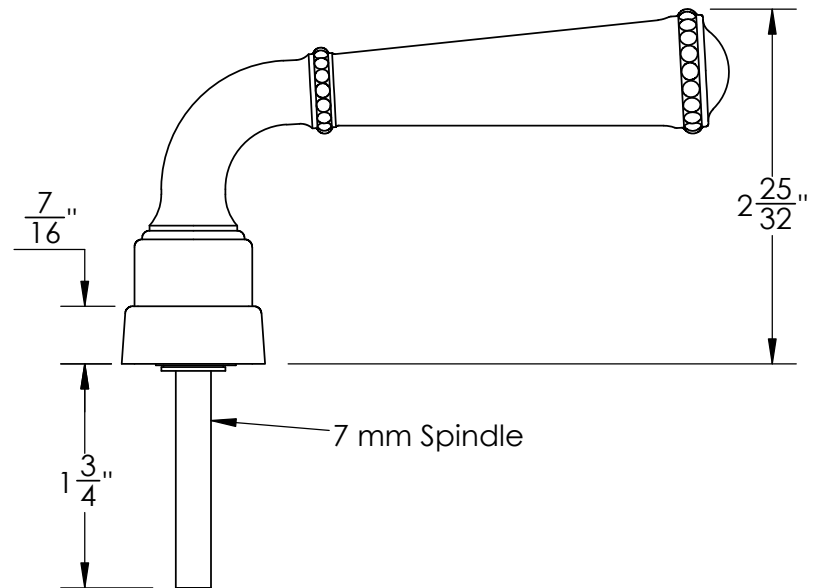

7 mm Spindle



Merit Metal Products Inc.
242 Valley Road
Warrington, PA 18976
P 215-343-2500 F 215-343-4839

The information contained in this drawing is the sole intellectual property of Merit Metal Products. Any reproduction in part or as a whole without the written permission of Merit Metal Products is prohibited.

Unless Otherwise Specified:

Dimensions are in inches

All dimensions are from edge, theoretical sharp corner, or hole center.

	NAME	DATE
Drawn:	AJE	12/02/2019

Comments:

TITLE:
**Window Multipoint
Tilt & Turn**

PART. NO.
925-TNT-00