

#5 Screws

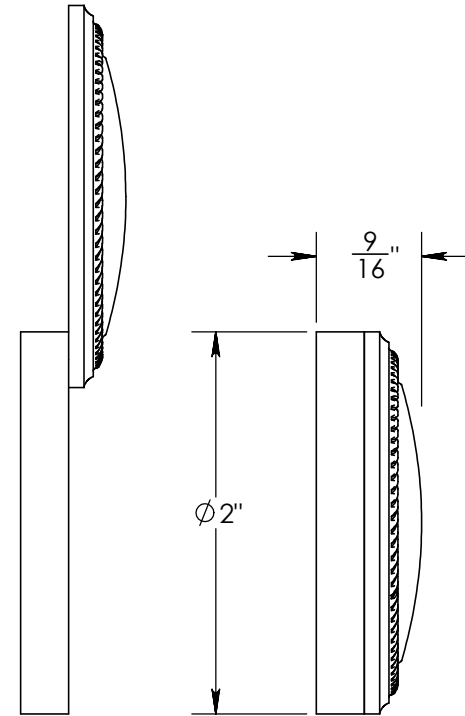

Collar adds 1/8"  
to required  
cylinder length



Merit Metal Products Inc.  
242 Valley Road  
Warrington, PA 18976  
P 215-343-2500 F 215-343-4839

The information contained in this drawing is the sole intellectual property of Merit Metal Products. Any reproduction in part or as a whole without the written permission of Merit Metal Products is prohibited.

Unless Otherwise Specified:

Dimensions are in inches

All dimensions are from edge, theoretical sharp corner, or hole center.

	NAME	DATE
Drawn:	AJE	9/30/2019

Comments:

TITLE:

**Rosemont Collection  
Roped Cylinder Swivel Cover**

PART. NO.

**92258**