



Shown with 484 lever on 518 style 2"x11" plate

Available with the following standard plate sizes:

1 <sup>3</sup> / <sub>8</sub> " x 11"	1 <sup>1</sup> / <sub>2</sub> " x 11"
1 <sup>5</sup> / <sub>8</sub> " x 11"	1 <sup>3</sup> / <sub>4</sub> " x 11"
2" x 11"	2 <sup>1</sup> / <sub>4</sub> " x 11"

Custom sizes also available

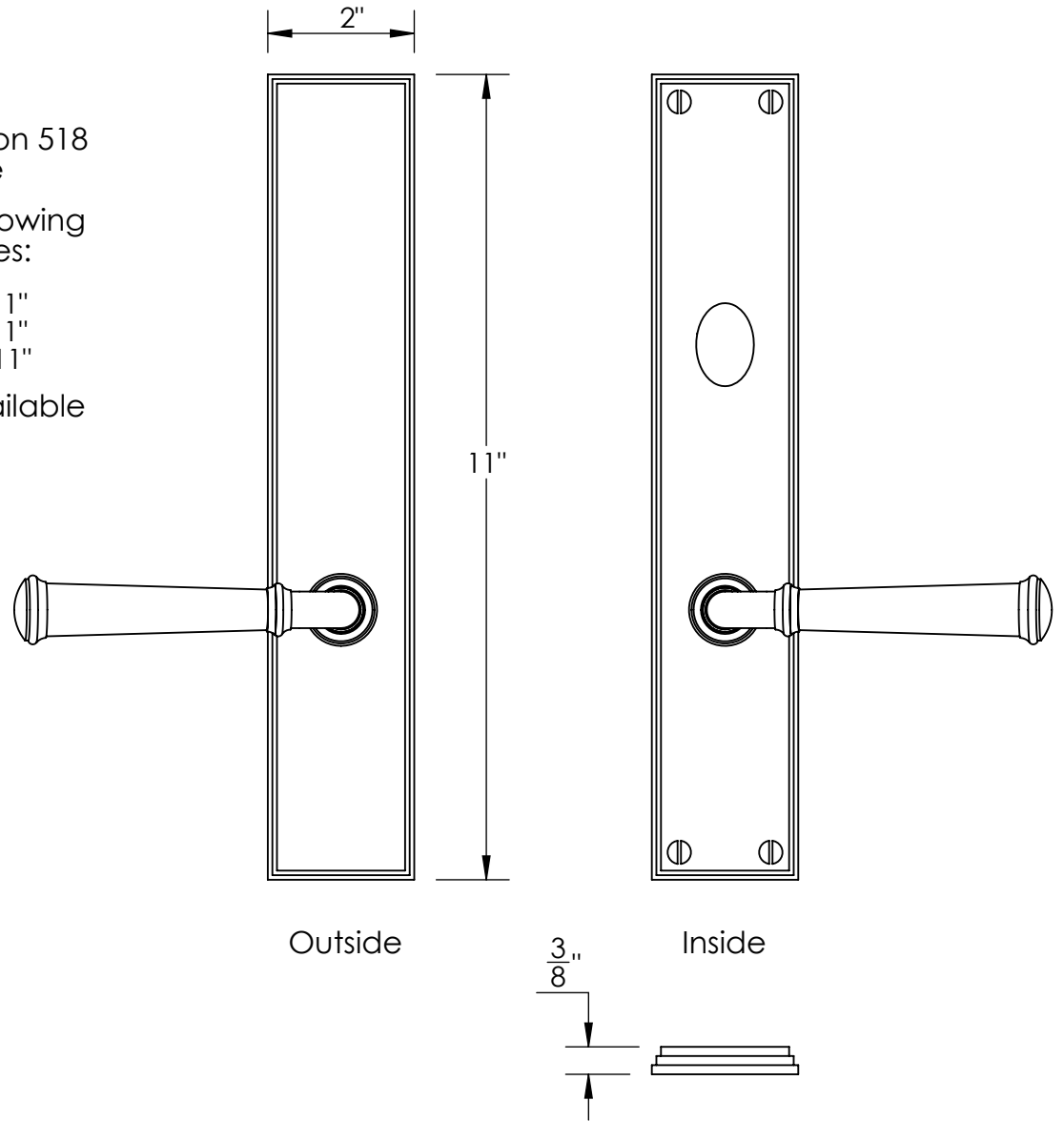

Merit Metal Products Inc.  
242 Valley Road  
Warrington, PA 18976  
P 215-343-2500 F 215-343-4839

The information contained in this drawing is the sole intellectual property of Merit Metal Products. Any reproduction in part or as a whole without the written permission of Merit Metal Products is prohibited.

Unless Otherwise Specified:

Dimensions are in inches

All dimensions are from edge, theoretical sharp corner, or hole center.

	NAME	DATE
Drawn:	AJC	5/1/2017

Comments:  
Part numbers configured at time of order

TITLE: **American Patio Function Multipoint Lever Low**

PART. NO. **484-7-4-12-11**