



Shown with 484 lever on 518 style 2"x11" plate

Available with the following standard plate sizes:

$1\frac{3}{8}" \times 11"$      $1\frac{1}{2}" \times 11"$   
 $1\frac{5}{8}" \times 11"$      $1\frac{3}{4}" \times 11"$   
 $2" \times 11"$          $2\frac{1}{4}" \times 11"$

Custom sizes also available

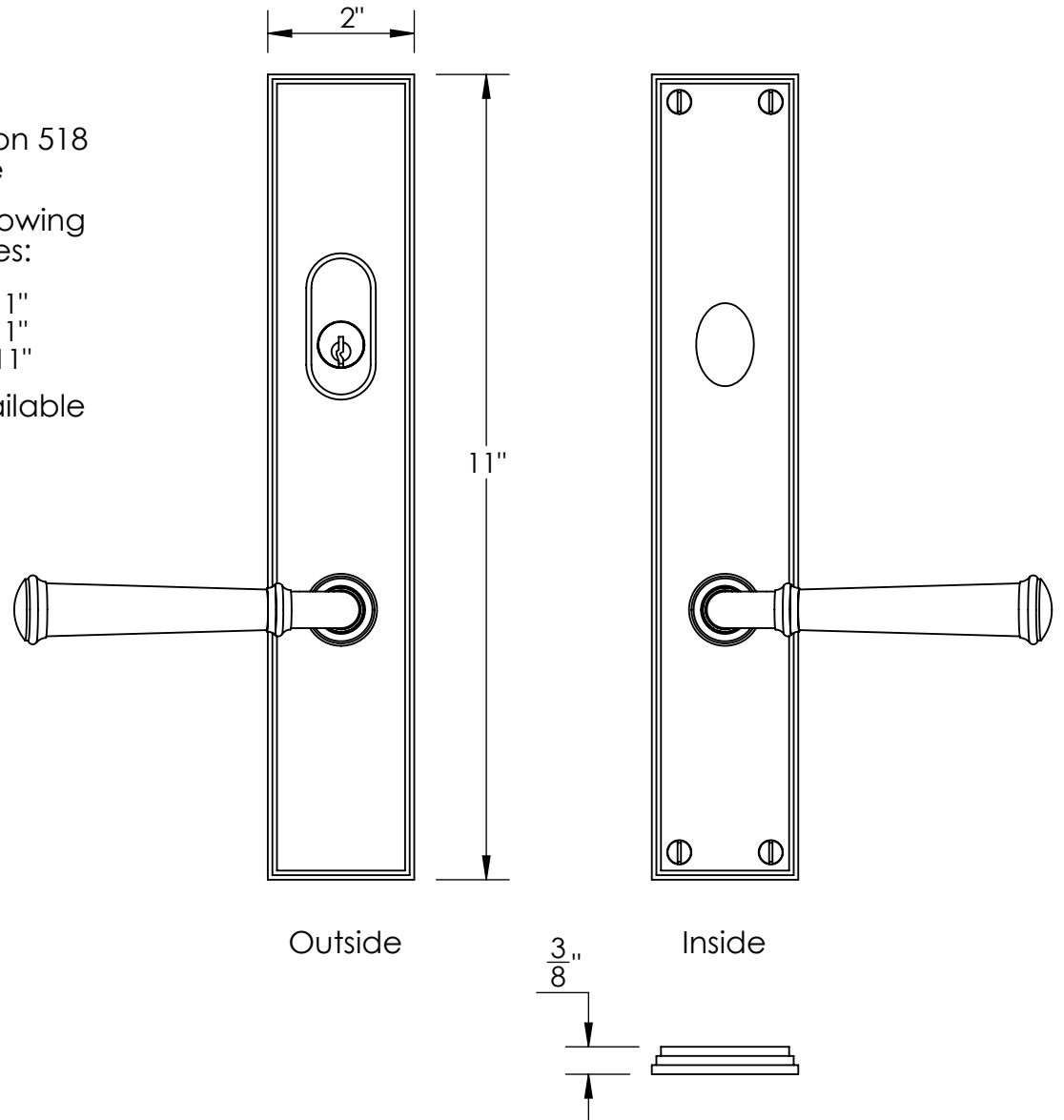

Merit Metal Products Inc.  
242 Valley Road  
Warrington, PA 18976  
P 215-343-2500 F 215-343-4839

The information contained in this drawing is the sole intellectual property of Merit Metal Products. Any reproduction in part or as a whole without the written permission of Merit Metal Products is prohibited.

Unless Otherwise Specified:

Dimensions are in inches

All dimensions are from edge, theoretical sharp corner, or hole center.

	NAME	DATE
Drawn:	AJC	5/1/2017

Comments:

Part numbers configured at time of order

TITLE:

**American Entrance  
Function Multipoint  
Lever Low**

PART. NO.

**484-7-4-11-11**