



Shown with 461 lever on 512 style 2"x11" plate

Available with the following standard plate sizes:

1 ³ / ₈ " x 11"	1 ¹ / ₂ " x 11"
1 ⁵ / ₈ " x 11"	1 ³ / ₄ " x 11"
2" x 11"	2 ¹ / ₄ " x 11"

Custom sizes also available

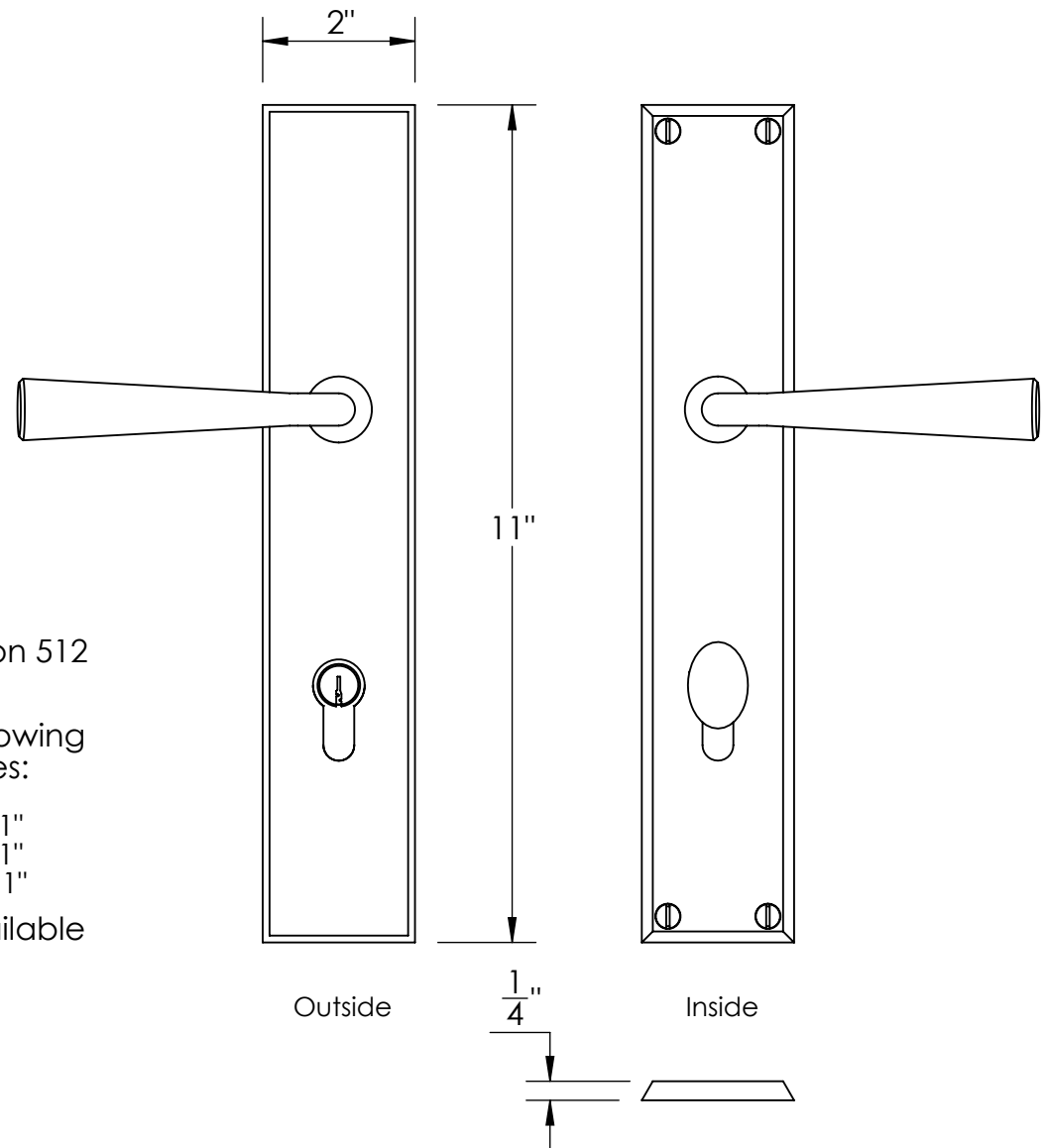

Merit Metal Products Inc.
242 Valley Road
Warrington, PA 18976
P 215-343-2500 F 215-343-4839

The information contained in this drawing is the sole intellectual property of Merit Metal Products. Any reproduction in part or as a whole without the written permission of Merit Metal Products is prohibited.

Unless Otherwise Specified:

Dimensions are in inches

All dimensions are from edge, theoretical sharp corner, or hole center.

	NAME	DATE
Drawn:	SKP	1/20/15

Comments:
Part numbers configured at time of order

TITLE:
**Euro Entrance
Function Multipoint**

PART. NO.
461-1-2-01-11