

Shown above: 484-WMP-01  
Other lever styles also available

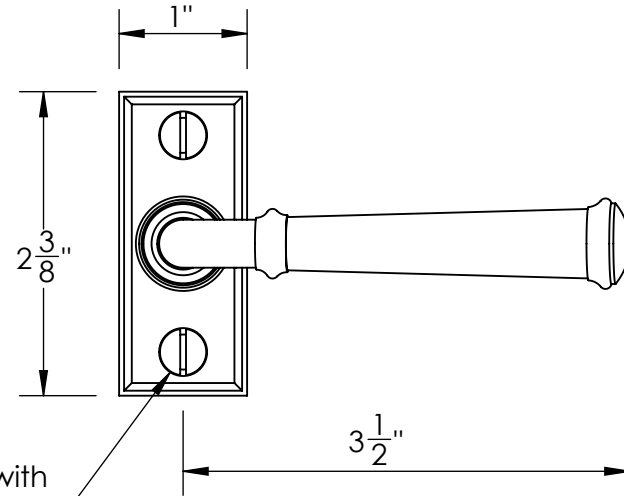

Comes standard with  
M5 X 25mm long screws

Available Backplate Styles:

-00  
standard  
1" x 2 3/8"



-01  
decorative  
1" x 2 3/8"



-02  
beveled  
1" x 2 3/8"



-03  
slab  
1" x 2 3/8"



-04  
stepped  
1" x 2 3/8"

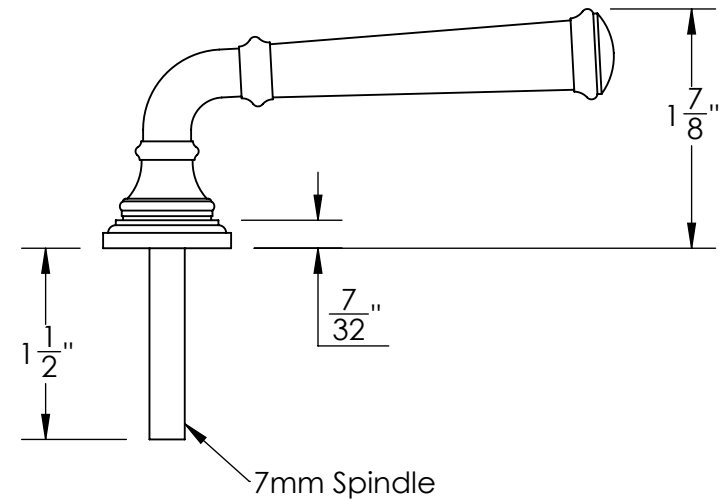

Merit Metal Products Inc.  
242 Valley Road  
Warrington, PA 18976  
P 215-343-2500 F 215-343-4839

The information contained in this drawing is the sole intellectual property of Merit Metal Products. Any reproduction in part or as a whole without the written permission of Merit Metal Products is prohibited.

Unless Otherwise Specified:

Dimensions are in inches

All dimensions are from edge, theoretical sharp corner, or hole center.

	NAME	DATE
Drawn:	SKP	1/20/15

Comments:

TITLE:  
**Window Multipoint**

PART. NO.  
**484-WMP-01**