

47852

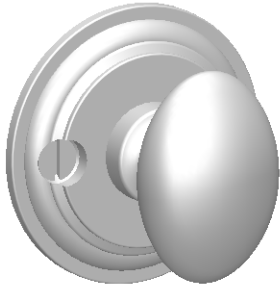

#5 Screws

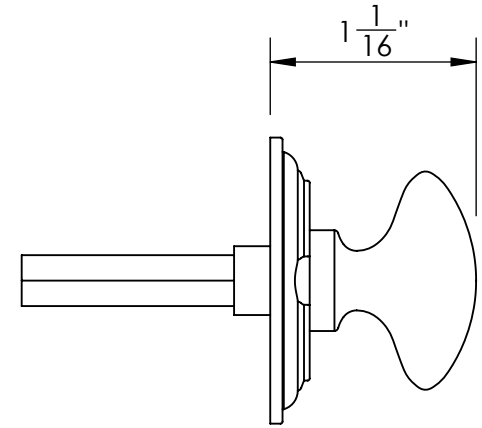
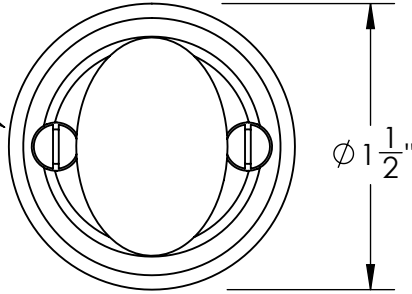

47853

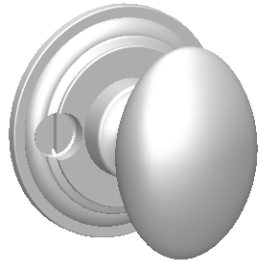

#5 Screws

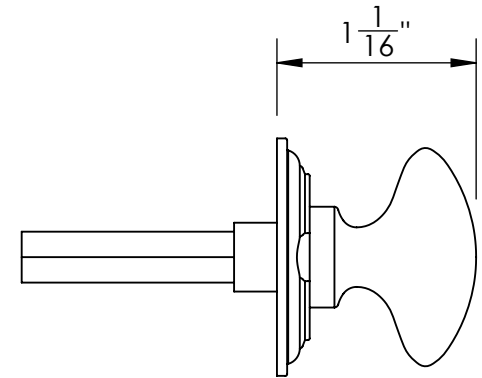
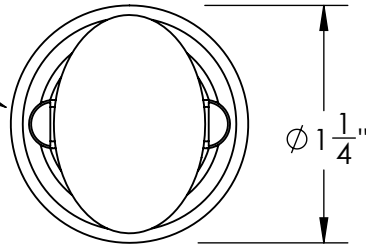

Merit Metal Products Inc.  
242 Valley Road  
Warrington, PA 18976  
P 215-343-2500 F 215-343-4839

The information contained in this drawing is the sole intellectual property of Merit Metal Products. Any reproduction in part or as a whole without the written permission of Merit Metal Products is prohibited.

Unless Otherwise Specified:

Dimensions are in inches

All dimensions are from edge, theoretical sharp corner, or hole center.

	NAME	DATE
Drawn:	JHR	1/20/15

Comments:

TITLE: **Gwynedd Collection  
Oval Thumbturn  
with 3/16" Spindle**

PART. NO.  
**47852 & 47853**