

476FDS-1

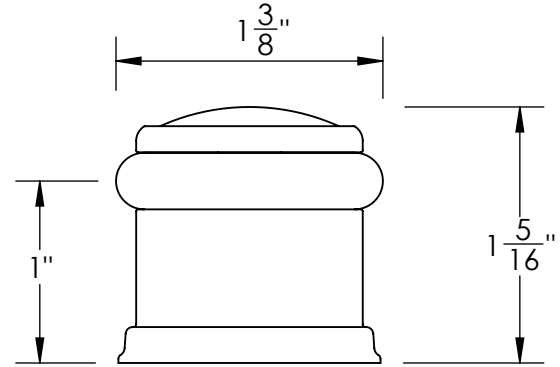

476FDS-2

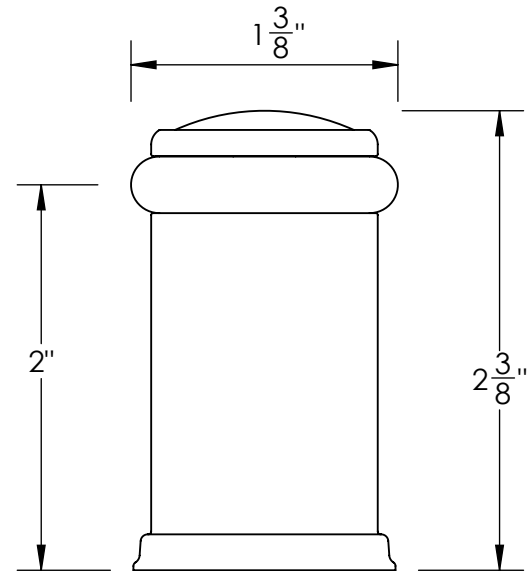
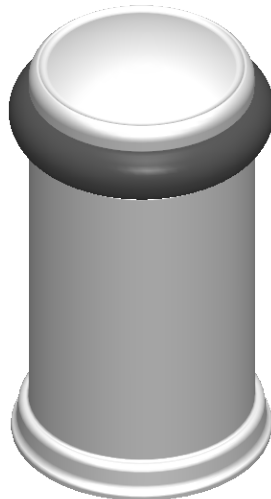

Merit Metal Products Inc.
242 Valley Road
Warrington, PA 18976
P 215-343-2500 F 215-343-4839

The information contained in this drawing is the sole intellectual property of Merit Metal Products. Any reproduction in part or as a whole without the written permission of Merit Metal Products is prohibited.

Unless Otherwise Specified:

Dimensions are in inches

All dimensions are from edge, theoretical sharp corner, or hole center.

| | | |
|--------|------|---------|
| | NAME | DATE |
| Drawn: | JHR | 1/20/15 |

Comments:

TITLE:
**Huntingdon Collection
Door Stop**

PART. NO.
476FDS-1 & 476FDS-2