

47670-.75

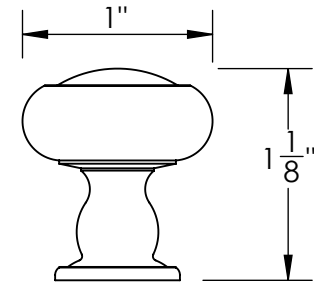

47670-1

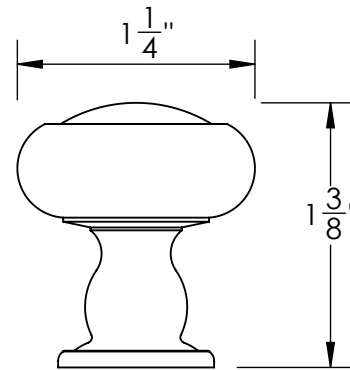

47670-1.25

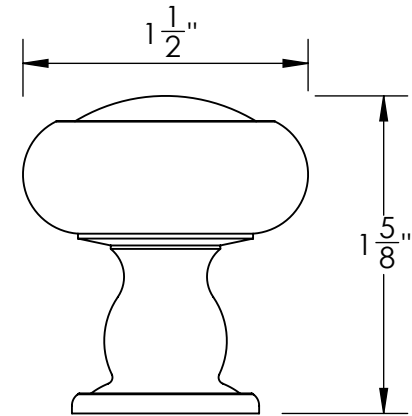

47670-1.5



Merit Metal Products Inc.
242 Valley Road
Warrington, PA 18976
P 215-343-2500 F 215-343-4839

The information contained in this drawing is the sole intellectual property of Merit Metal Products. Any reproduction in part or as a whole without the written permission of Merit Metal Products is prohibited.

Unless Otherwise Specified:

Dimensions are in inches

All dimensions are from edge, theoretical sharp corner, or hole center.

	NAME	DATE
Drawn:	JHR	1/20/15

Comments:

TITLE:

**Huntingdon Collection
Cabinet Knob**

PART. NO.

**47670-.75 47670-1
47670-1.25 47670-1.5**