

46250

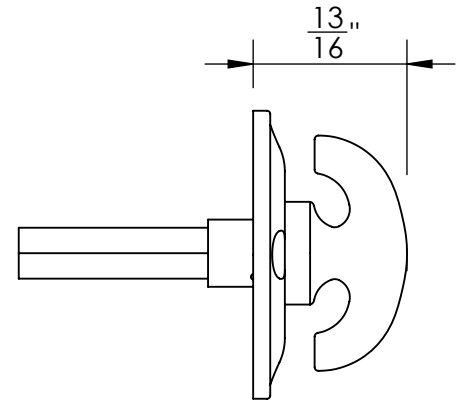

#5 Screws

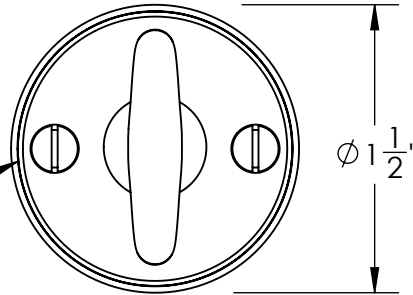

46251



#5 Screws

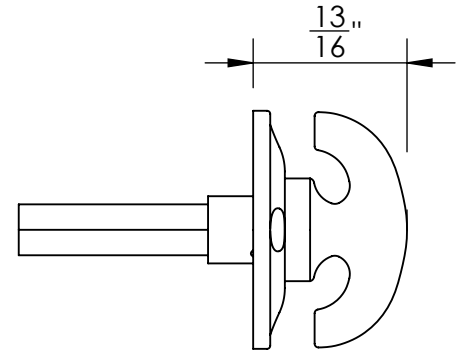
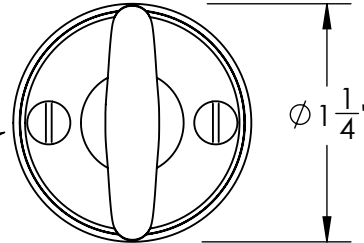

Merit Metal Products Inc.
242 Valley Road
Warrington, PA 18976
P 215-343-2500 F 215-343-4839

The information contained in this drawing is the sole intellectual property of Merit Metal Products. Any reproduction in part or as a whole without the written permission of Merit Metal Products is prohibited.

Unless Otherwise Specified:
Dimensions are in inches
All dimensions are from edge, theoretical sharp corner, or hole center.

	NAME	DATE
Drawn:	JHR	1/20/15

Comments:

TITLE: **Gwynedd Collection
Crescent Thumbturn
with 3/16" Spindle**

PART. NO.
46250 & 46251