

44856

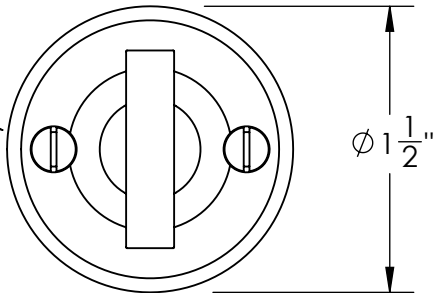

#5 Screws



Ø 1 1/2"

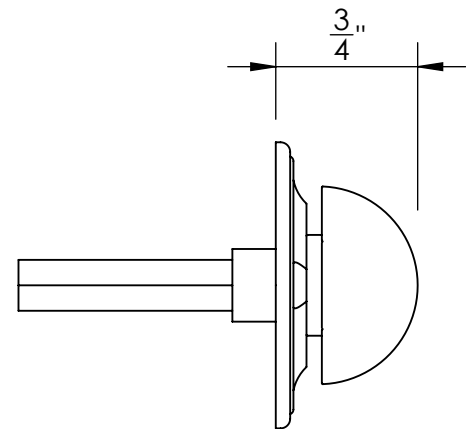

3/4"

44857



#5 Screws

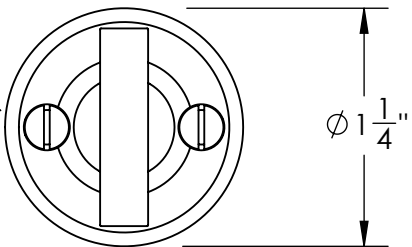

Ø 1 1/4"

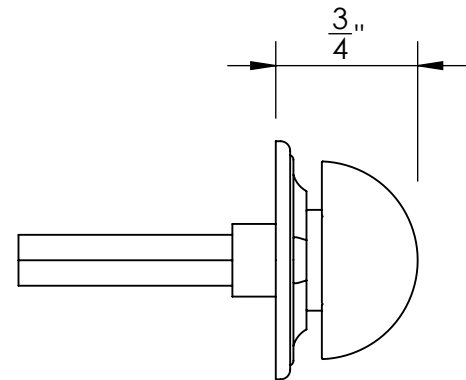

3/4"



Merit Metal Products Inc.
242 Valley Road
Warrington, PA 18976
P 215-343-2500 F 215-343-4839

The information contained in this drawing is the sole intellectual property of Merit Metal Products. Any reproduction in part or as a whole without the written permission of Merit Metal Products is prohibited.

Unless Otherwise Specified:

Dimensions are in inches

All dimensions are from edge, theoretical sharp corner, or hole center.

	NAME	DATE
Drawn:	JHR	1/20/15

Comments:

TITLE: **Huntingdon Collection
Modern Thumbturn with
3/16" Spindle**

PART. NO.
44856 & 44857